

WOOD CHIPS



Northwest Indiana Woodworkers Association

Volume 17, Issue 5 May 2013

President's Corner

Hi Woodworkers, We are all busy getting things ready for Memorial Day. Remember those that have given their lives for this wonderful country we live in. Remember those that have fought so bravely and are still alive. Put your flags out and fly them proudly. God Bless You and God Bless America!

I hope you are enjoying working in the shop as much as I am. There are no bugs yet. The breeze is perfect and the days are longer. Life is good!
While you are in the shop please make some toys for the kids. They're depending on you!

May Program This is going to be an exciting meeting. We will be featuring Kevin Sturgeon demonstrating his lathe talents. Dick Sader will be demonstrating scroll sawing. Ken Garbe and Marcia Lichnerowicz will be demonstrating the Ring Master. There will be a short business meeting then on to having fun!

Dues are due Yes it's that time of year again. Good news. Dues have not gone up. If you haven't paid yet see our treasurer. Keep in mind that if you do a shop visit the next year your dues are free as an appreciation of the club for your effort.

Carving SIG will be going on at 6pm before the membership meeting. There's a lot of talented carving going on. Stop in and join us.

Ornaments made for the Welcome Center Tree can be given to Marcia Lichnerowicz. We are hoping to have enough ornaments to have a larger tree this year.

See you at the meeting!

Marcia Lichnerowicz
President NIWA

SHOW AND TELL



Frank Schmidt

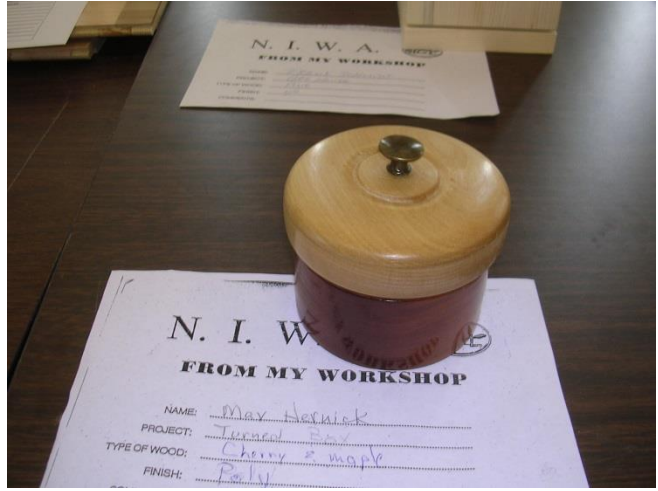

Max Hernick



Ken Garbe



Bob Miller



Marcia Lichnerowicz



Carrie McGinty

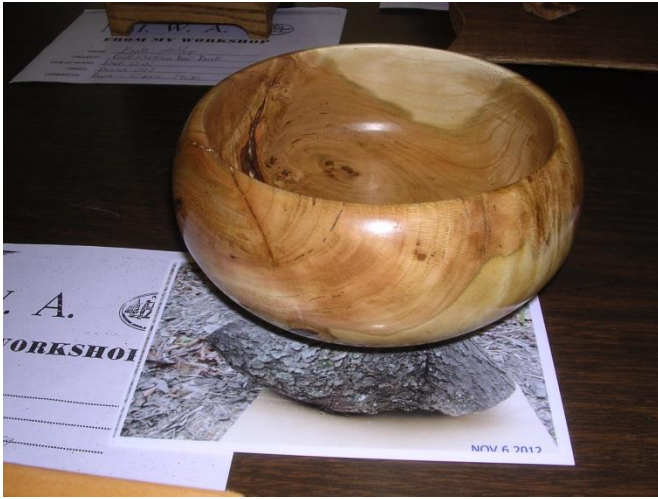

Joe McDaniel



Leon Kozlowski



Kevin Sturgeon



Dick Sader



John Hunter



Carrie McGinty



Fred Bogwill

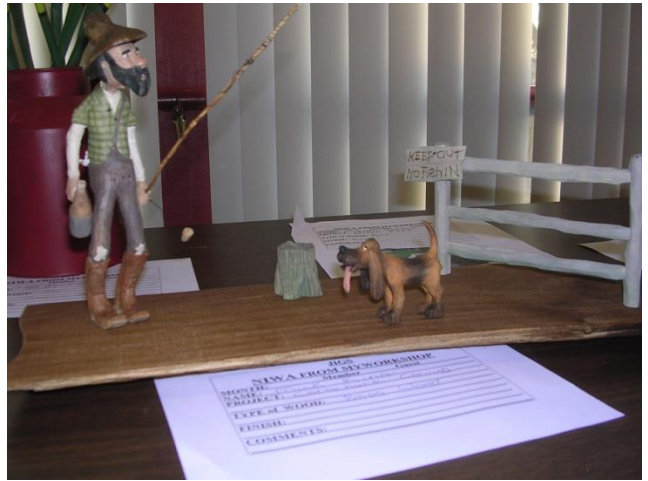

Mick King

2 X 4 CHALLENGE



Ken Garbe



Joe McDaniel

..

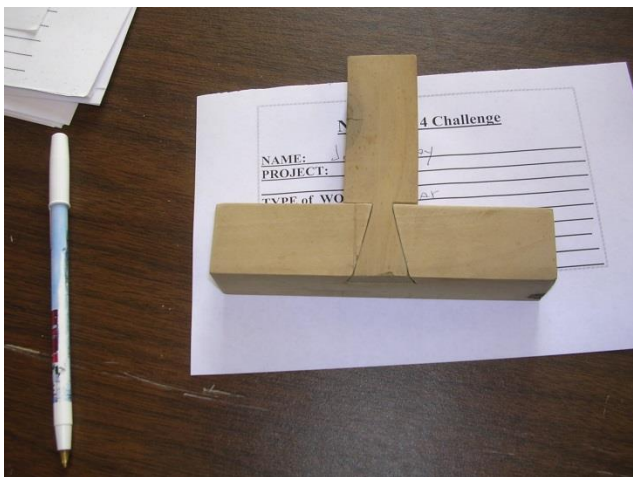

Jesse Day

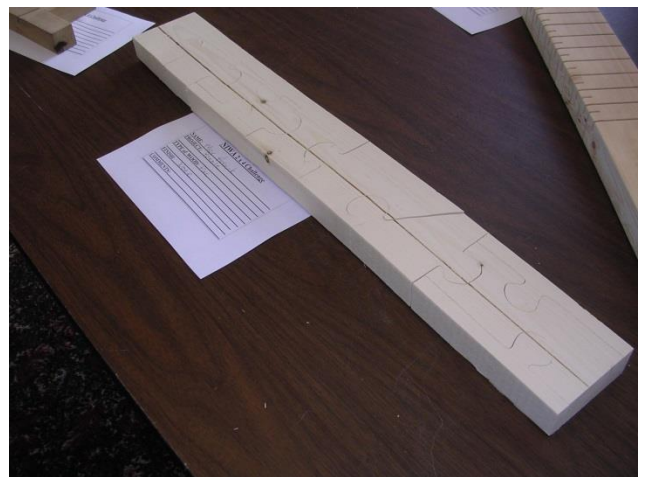

Max Hernick



Kris Hahn



Rodney Foster



John Hunter

SPECIAL DRAWING THIS MONTH!

Member Bob Jancich donated a Delta Dado set to raise funds for our Toys for Kids Program. It will be raffled off at the May meeting, be sure and see Phil for some tickets.



SHOP VISIT

Dick Sader and Ron Benson will be hosting a combined shop visit on May 25th from 10:00 till 2:00. They are neighbors so you get to visit two shops in one visit! Dick's address is; 3059 Randolph St. Portage Indiana

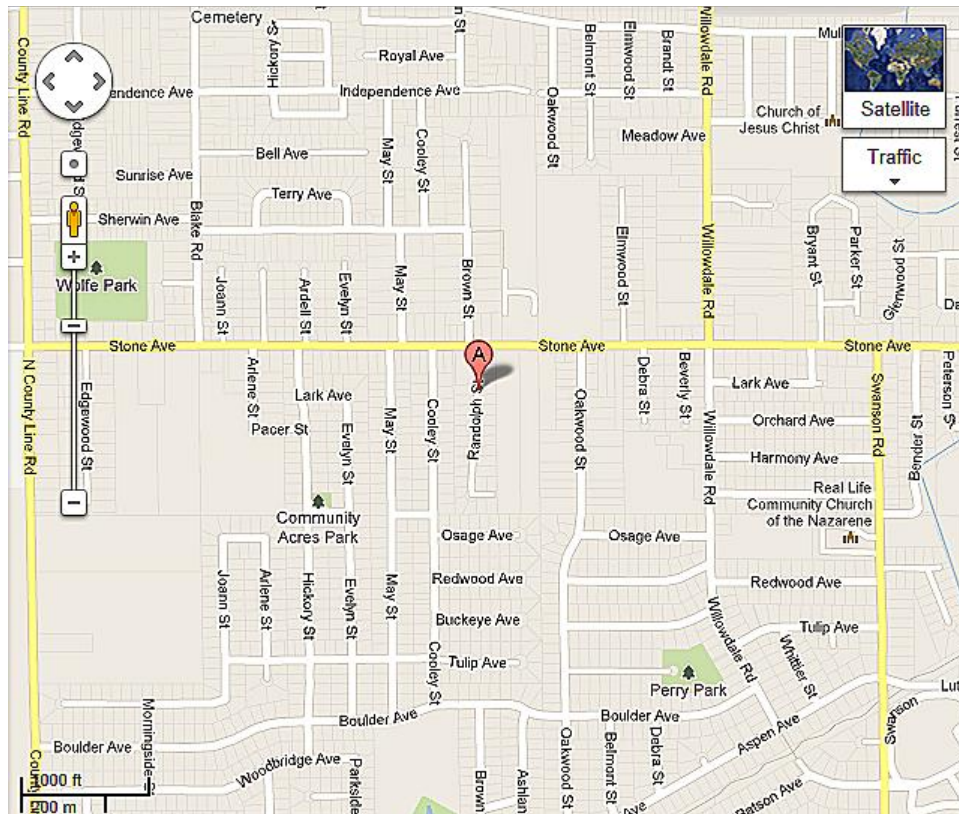

ITEMS FOR SALE

If you have any wood working related items that you wish to sell through the newsletter please contact John Hunter john.b.hunter@frontier.com Include a description and the price you are selling them for, also how you may be contacted.

If you are looking for a tool that another member would like to sell you can place a wanted ad in the newsletter, just contact John Hunter at john.b.hunter@frontier.com

CALENDAR OF EVENTS

2013

- May 23rd Membership Meeting at Hidden Lake 7:00 PM
- May 25th Shop Visit with Dick Sader & Ron Benson 10 AM – 2 PM
- June 18th Committees Meeting at Marcie's home 7:00 PM

June 27th Membership Meeting at Hidden Lake 7:00 PM
July 1st Executive Board Meeting at Ron Benson's home 7 PM
July 16th Committees Meeting at Marcie's home 7:00 PM
July 25th Membership Meeting at Hidden Lake 7:00 PM
August 1st Set Up Club Booth at Lake County Fair 9 PM
August 2nd – 5th Club Booth at Lake County Fair 10 AM – 10 PM
August 20th Committees Meeting at Marcie's home 7:00 PM
August 22nd Membership Meeting at Hidden Lake 7:00 PM
August 25th Club Picnic at Hidden Lake Park 12 Noon
September 17th Committees Meeting at Marcie's home 7:00 PM
September 26th Membership Meeting at Hidden Lake 7:00 PM
October 7th Executive Board Meeting at Ron Benson's home 7 PM
October 15th Committees Meeting at Marcie's home 7:00 PM
October 24th Membership Meeting at Hidden Lake 7:00 PM
November 19th Committees Meeting at Marcie's home 7:00 PM
November 14th Membership Meeting at Hidden Lake 7:00 PM Toy Program
December 17th Committees Meeting at Marcie's home 7:00 PM
December 19th Membership Meeting at Hidden Lake 6:00 PM Christmas Party,
Installation and Awards

Bob Flexner's Finishing Tips

<http://www.thefinishingstore.com/>

TIP: Strain Water-Based Finish

It's always a good idea to strain a finish before brushing or spraying it to remove dirt and other unwanted particles. It's especially important to strain water-based finishes because small bits of finish often solidify in the can, and rust that forms around the lip of the can may fall into the finish.

Commercial strainers are widely available wherever paints and finishes are sold. These strainers are much easier to use than any homemade cloth system you may think up.



Strain Water-Based Finish

Straining always involves using a separate container, which can be the spray-gun cup itself if you're spraying, or a jar or plastic container if you're brushing. It's best to brush from a separate container anyway, in order not to introduce dust and dirt your brush may pick up back into your main supply.

Sheet Stock Dolly



As I get older, the sheet stock that I have to manhandle into and around the shop seems to get heavier and heavier. So rather than continue to rely on brute strength, I built the wheeled helper you see in the photo.

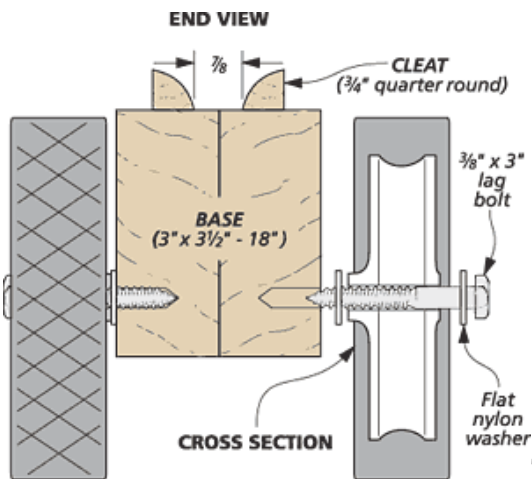

This dolly relies on a pair of large-diameter lawnmower wheels to negotiate bumps, cords, and other obstacles. The wheels sandwich a thick support block glued up from scraps of 2x4. A pair of cleats glued to the top of the block keeps the material being moved in place on the dolly.

When using the dolly, I try to position it close to the center of the sheet. This gives me the best balance and control. And every time I effortlessly maneuver a heavy sheet of MDF around the shop, I'm thankful for this simple idea.

Good Woodworking,

Ted Raife
Online Editor, *Woodsmith*